

Article number: 2061710A

Description: E+G Steel indexing plunger
GN 617-10-A

Measures

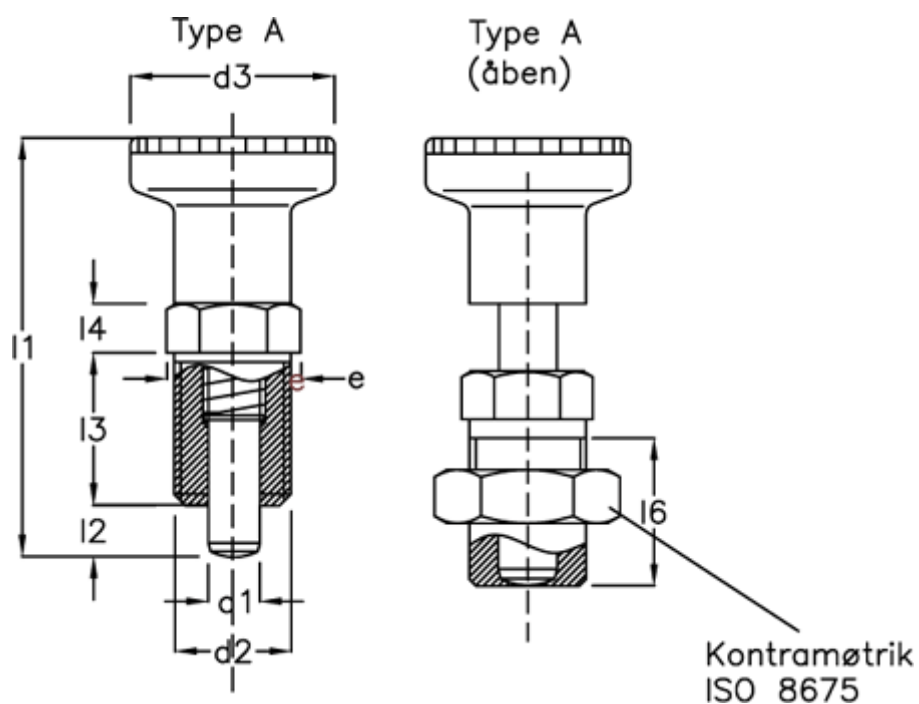

$d1 = 10$	$l6 = 30$
$d2 = M20 \times 1,5$	$NV = 22$
$d3 = 31$	Spring pressure N bottom = 45
$e = 25.4$	Spring pressure N top = 20.0
$l1 = 80.0$	
$l2 = 10$	
$l3 = 33$	
$l4 = 10$	